

# High Speed IGBT

# IXSH 20N60B2D1

$$V_{CES} = 600 \text{ V}$$

$$I_{C25} = 35 \text{ A}$$

$$V_{CE(sat)} = 2.5 \text{ V}$$

Short Circuit SOA Capability

## Preliminary Data Sheet

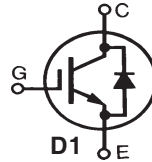

### TO-247 (IXSH)

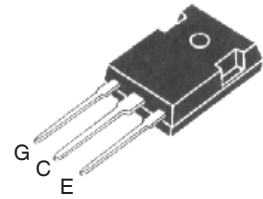

G = Gate      C = Collector  
E = Emitter    TAB = Collector

Symbol	Test Conditions	Maximum Ratings	
$V_{CES}$	$T_J = 25^\circ\text{C to } 150^\circ\text{C}$	600	V
$V_{CGR}$	$T_J = 25^\circ\text{C to } 150^\circ\text{C}; R_{GE} = 1 \text{ M}\Omega$	600	V
$V_{GES}$	Continuous	$\pm 20$	V
$V_{GEM}$	Transient	$\pm 30$	V
$I_{C25}$	$T_C = 25^\circ\text{C}$	35	A
$I_{C110}$	$T_C = 110^\circ\text{C}$	20	A
$I_{F(110)}$		21	A
$I_{CM}$	$T_C = 25^\circ\text{C}, 1 \text{ ms}$	60	A
<b>SSOA (RBSOA)</b>	$V_{GE} = 15 \text{ V}, T_J = 125^\circ\text{C}, R_G = 82\Omega$ Clamped inductive load	$I_{CM} = 32$ @ $0.8 V_{CES}$	A
<b><math>t_{SC}</math> (SCSOA)</b>	$V_{GE} = 15 \text{ V}, V_{CE} = 360 \text{ V}, T_J = 125^\circ\text{C}$ $R_G = 82 \Omega$ , non repetitive	10	$\mu\text{s}$
$P_C$	$T_C = 25^\circ\text{C}$	190	W
$T_J$		-55 ... +150	$^\circ\text{C}$
$T_{JM}$		150	$^\circ\text{C}$
$T_{stg}$		-55 ... +150	$^\circ\text{C}$
<b>Weight</b>		2	g
Maximum lead temperature for soldering 1.6 mm (0.062 in.) from case for 10 s		300	$^\circ\text{C}$
Maximum tab temperature for soldering for 10s		260	$^\circ\text{C}$

### Features

- International standard package
- Guaranteed Short Circuit SOA capability
- Low  $V_{CE(sat)}$ 
  - for low on-state conduction losses
- High current handling capability
- MOS Gate turn-on
  - drive simplicity
- Fast fall time for switching speeds up to 20 kHz

### Applications

- AC motor speed control
- Uninterruptible power supplies (UPS)
- Welding

### Advantages

- High power density

Symbol	Test Conditions	Characteristic Values ( $T_J = 25^\circ\text{C}$ , unless otherwise specified)		
		min.	typ.	max.
$BV_{CES}$	$I_C = 250 \mu\text{A}, V_{GE} = 0 \text{ V}$	600		V
$V_{GE(th)}$	$I_C = 750 \mu\text{A}, V_{CE} = V_{GE}$	3.5		V
$I_{CES}$	$V_{CE} = V_{CES}$ $V_{GE} = 0 \text{ V}$			85 $\mu\text{A}$ 0.6 mA
$I_{GES}$	$V_{CE} = 0 \text{ V}, V_{GE} = \pm 20 \text{ V}$			$\pm 100 \text{ nA}$
$V_{CE(sat)}$	$I_C = 16 \text{ A}, V_{GE} = 15 \text{ V}$			2.5 V

Symbol	Test Conditions	Characteristic Values ( $T_J = 25^\circ\text{C}$ , unless otherwise specified)		
		min.	typ.	max.
$g_{fs}$	$I_C = 16\text{A}; V_{CE} = 10\text{V}$ , Note 1	3.5	7.0	S
$C_{ies}$			800	pF
$C_{oes}$	$V_{CE} = 25\text{V}, V_{GE} = 0\text{V}$		110	pF
$C_{res}$	$f = 1\text{MHz}$		28	pF
$Q_g$			33	nC
$Q_{ge}$	$I_C = 16\text{A}, V_{GE} = 15\text{V}, V_{CE} = 0.5 V_{CES}$		12	nC
$Q_{gc}$			12	nC
$t_{d(on)}$	<b>Inductive load, <math>T_J = 25^\circ\text{C}</math></b>		30	ns
$t_{ri}$	$I_C = 16\text{A}, V_{GE} = 15\text{V}$		30	ns
$t_{d(off)}$	$V_{CE} = 0.8 V_{CES}, R_G = 10\ \Omega$		116	ns
$t_{fi}$	Switching times may increase for $V_{CE}$ (Clamp) $> 0.8 \cdot V_{CES}$ , higher $T_J$ or increased $R_G$		126	ns
$E_{off}$			380	600 $\mu\text{J}$
$t_{d(on)}$	<b>Inductive load, <math>T_J = 125^\circ\text{C}</math></b>		30	ns
$t_{ri}$	$I_C = 16\text{A}, V_{GE} = 15\text{V}$		30	ns
$E_{on}$	$V_{CE} = 0.8 V_{CES}, R_G = 10\ \Omega$		0.52	mJ
$t_{d(off)}$	Switching times may increase for $V_{CE}$ (Clamp) $> 0.8 \cdot V_{CES}$ , higher $T_J$ or increased $R_G$		180	ns
$t_{fi}$			210	ns
$E_{off}$			970	$\mu\text{J}$
$R_{thJC}$				0.66 K/W
$R_{thCS}$			0.25	K/W

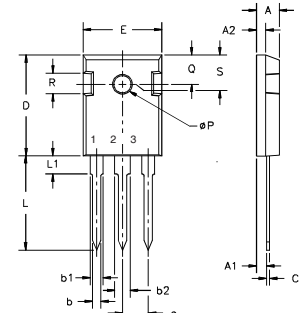
**TO-247 Outline**

 Terminals: 1 - Gate 2 - Drain  
 3 - Source Tab - Drain

Dim.	Millimeter		Inches	
	Min.	Max.	Min.	Max.
A	4.7	5.3	.185	.209
A <sub>1</sub>	2.2	2.54	.087	.102
A <sub>2</sub>	2.2	2.6	.059	.098
b	1.0	1.4	.040	.055
b <sub>1</sub>	1.65	2.13	.065	.084
b <sub>2</sub>	2.87	3.12	.113	.123
C	.4	.8	.016	.031
D	20.80	21.46	.819	.845
E	15.75	16.26	.610	.640
e	5.20	5.72	0.205	0.225
L	19.81	20.32	.780	.800
L1		4.50		.177
$\varnothing P$	3.55	3.65	.140	.144
Q	5.89	6.40	0.232	0.252
R	4.32	5.49	.170	.216
S	6.15	BSC	.242	BSC

Symbol	Test Conditions	Characteristic Values ( $T_J = 25^\circ\text{C}$ , unless otherwise specified)		
		min.	typ.	max.
$V_F$	$I_F = 15\text{A}, V_{GE} = 0\text{V}$	$T_J = 150^\circ\text{C}$		1.35 V 2.10 V
$I_{RM}$	$I_F = 25\text{A}, V_{GE} = 0\text{V}, -di_F/dt = 100\text{A}/\mu\text{s}$	$T_J = 100^\circ\text{C}$	4.5	A
$t_{rr}$	$V_R = 100\text{V}$	$T_J = 100^\circ\text{C}$	110	ns
$t_{rr}$	$I_F = 1\text{A}; -di/dt = 100\text{A}/\mu\text{s}; V_R = 30\text{V}$		30	ns
$R_{thJC}$				1.6 K/W

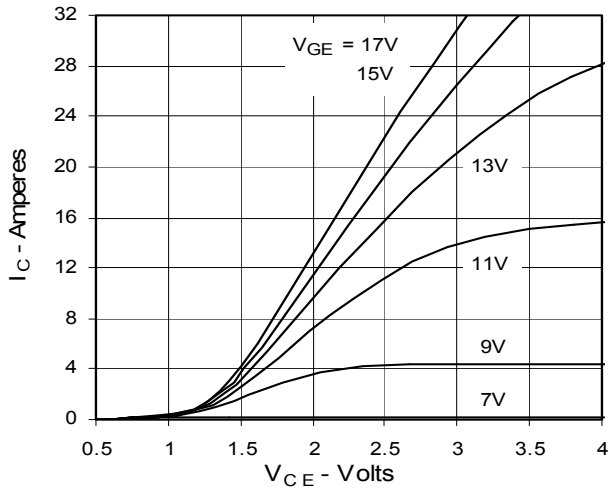
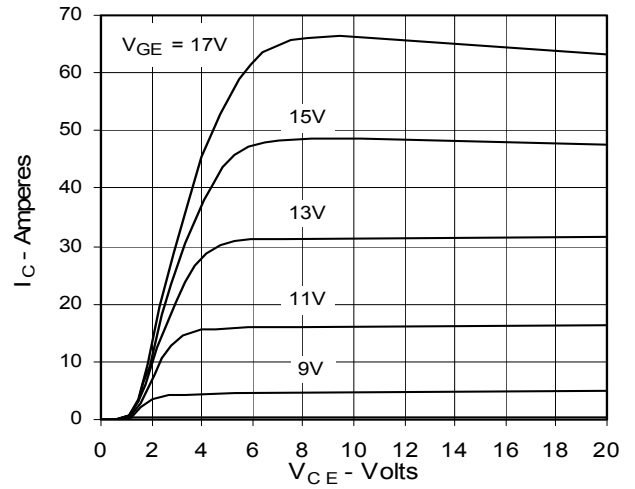
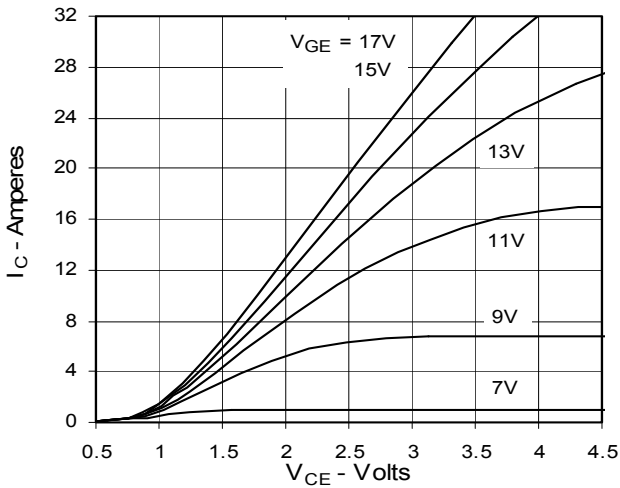
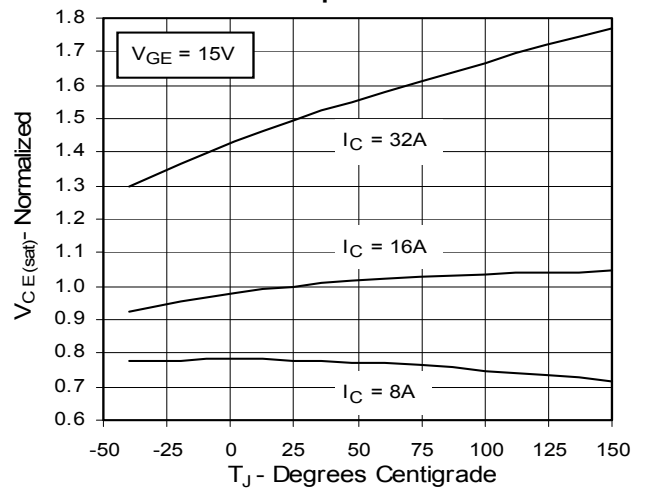
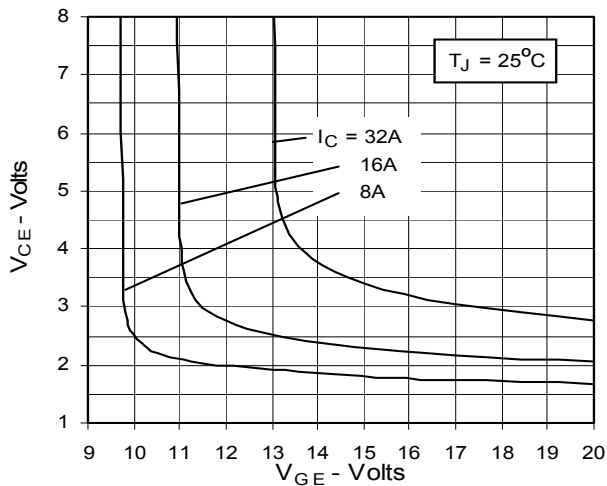
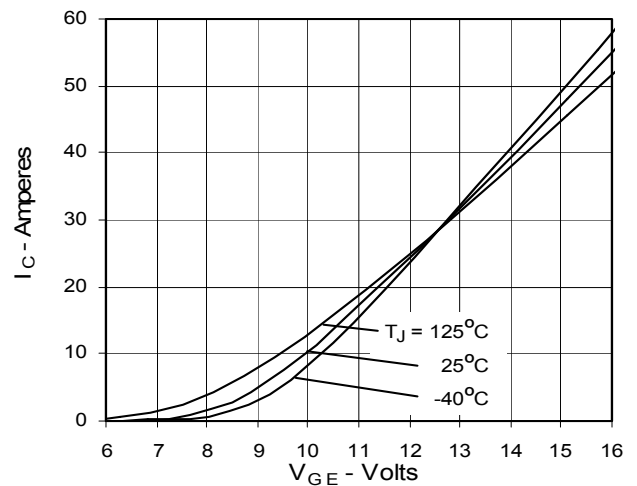
 Note 1: Pulse test,  $t \leq 300\ \mu\text{s}$ , duty cycle  $d \leq 2\%$

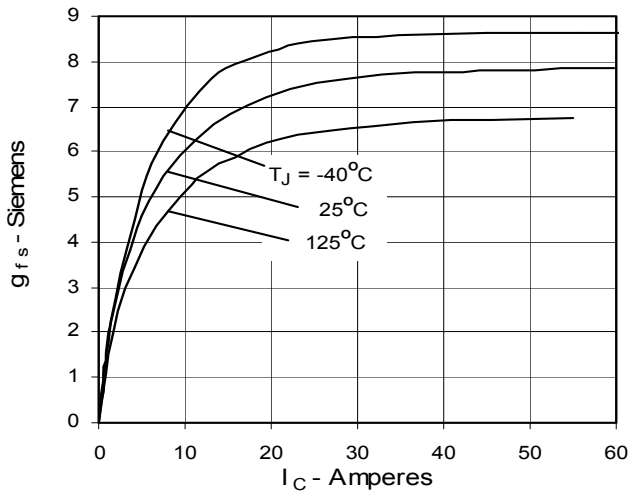
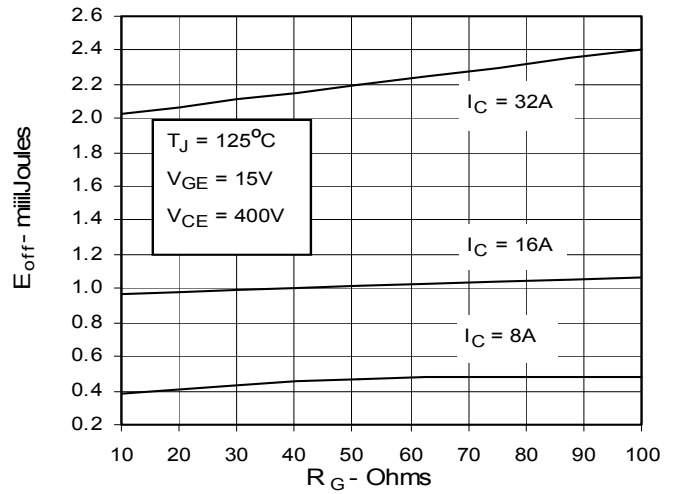
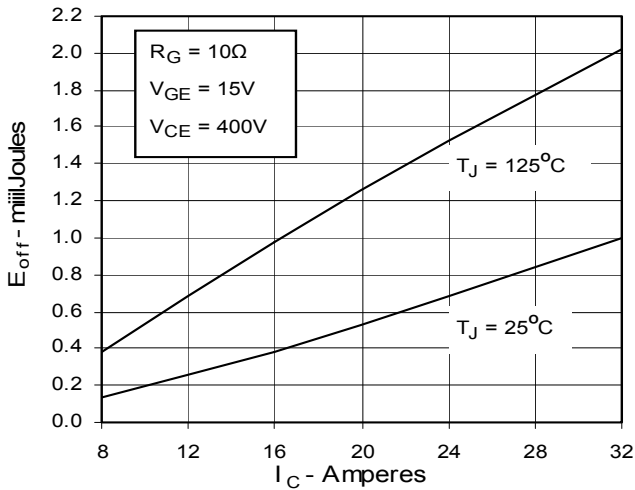
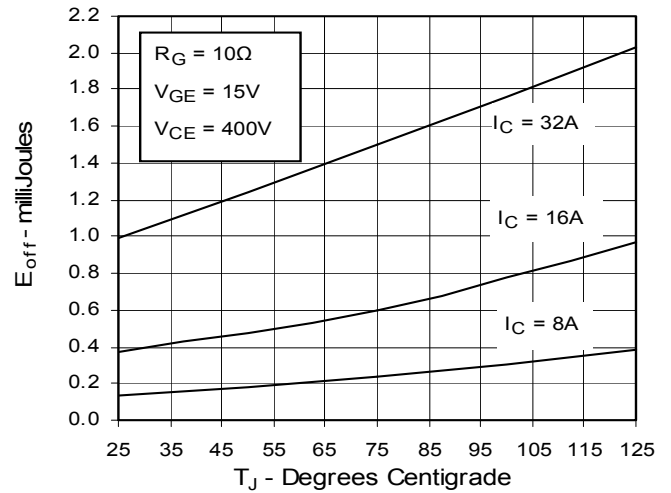
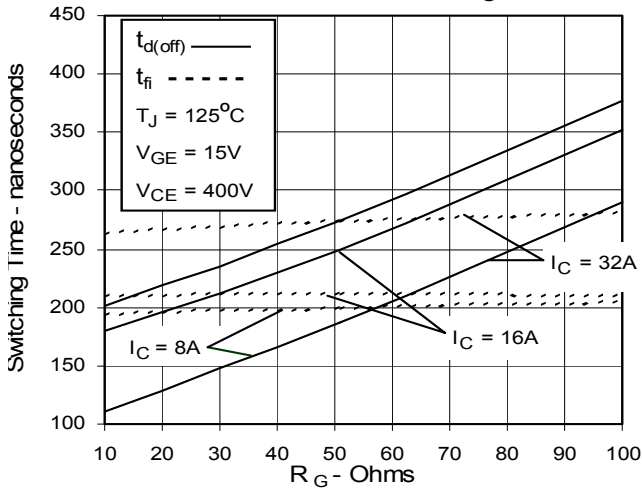
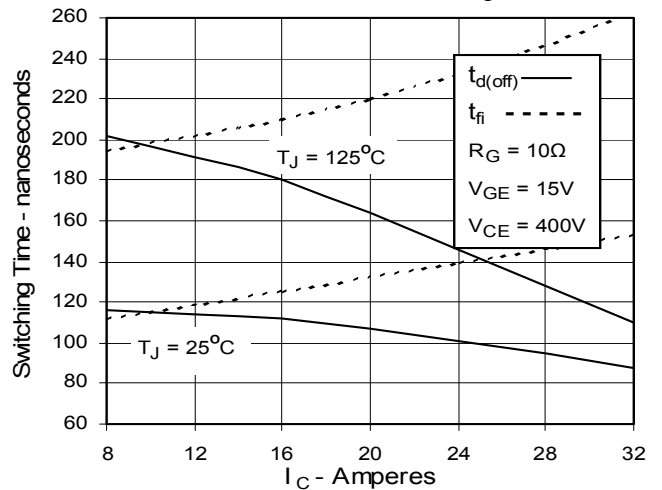
**Fig. 1. Output Characteristics  
@ 25 °C**

**Fig. 2. Extended Output Characteristics  
@ 25 °C**

**Fig. 3. Output Characteristics  
@ 125 °C**

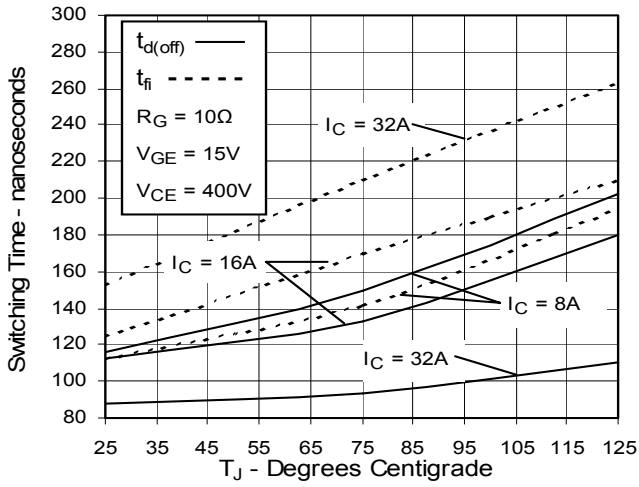
**Fig. 4. Dependence of  $V_{CE(sat)}$  on  
Temperature**

**Fig. 5. Collector-to-Emitter Voltage  
vs. Gate-to-Emitter voltage**

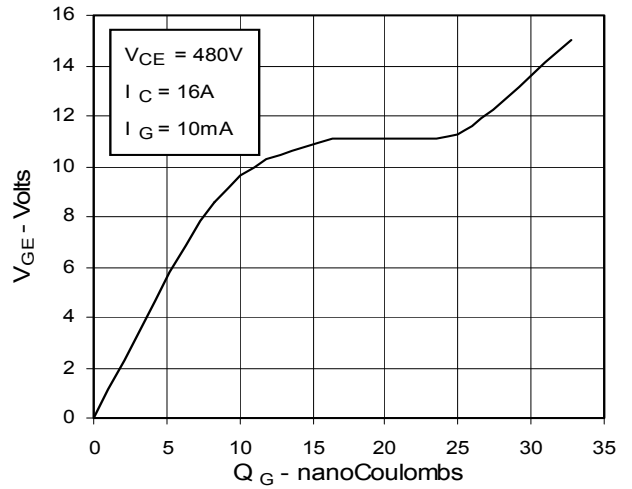
**Fig. 6. Input Admittance**

**Fig. 7. Transconductance**

**Fig. 8. Dependence of Turn-off Energy Loss on  $R_G$** 

**Fig. 9. Dependence of Turn-Off Energy Loss on  $I_C$** 

**Fig. 10. Dependence of Turn-off Energy Loss on Temperature**

**Fig. 11. Dependence of Turn-off Switching Time on  $R_G$** 

**Fig. 12. Dependence of Turn-off Switching Time on  $I_C$** 

**Fig. 13. Dependence of Turn-off Switching Time on Temperature**



**Fig. 14. Gate Charge**



**Fig. 15. Capacitance**

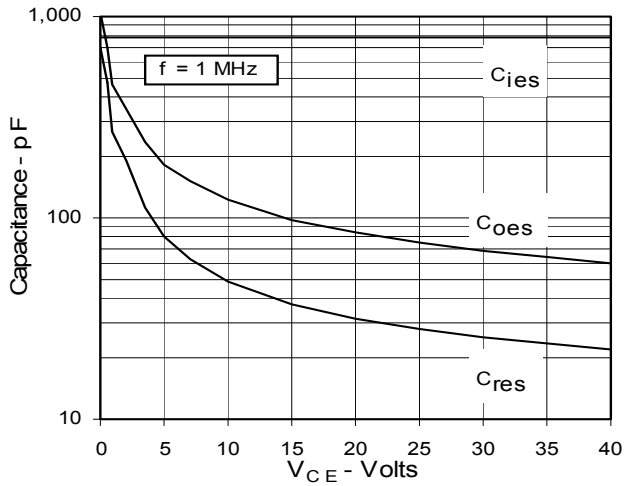

**Fig. 16. Reverse-Bias Safe Operating Area**

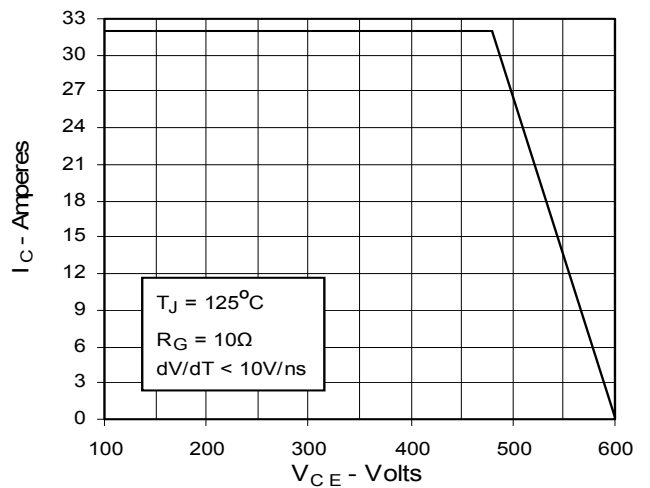

**Fig. 17. Maximum Transient Thermal Resistance**

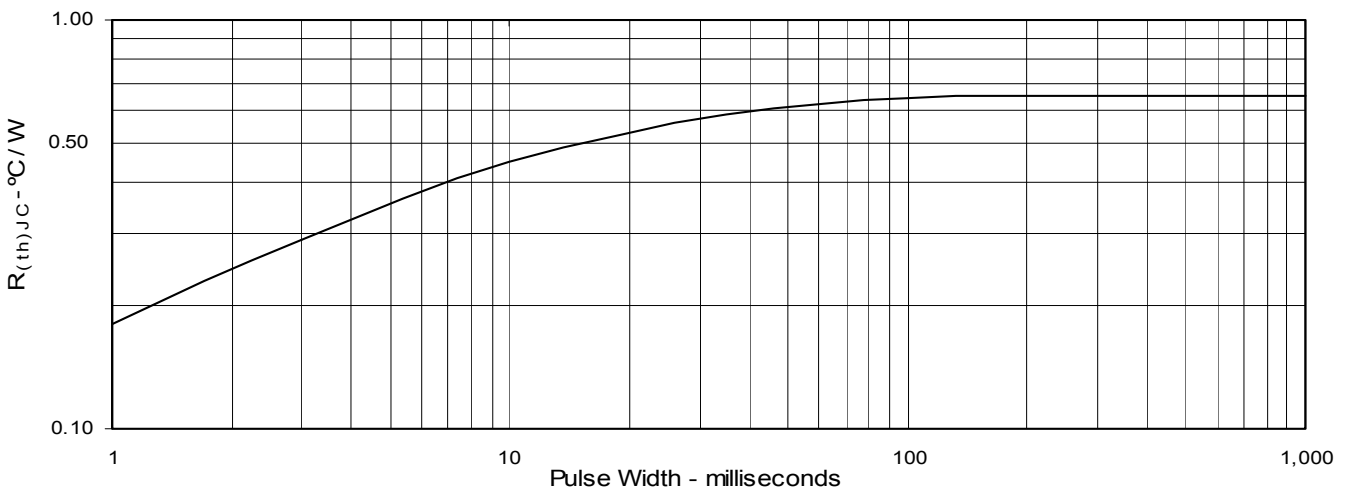

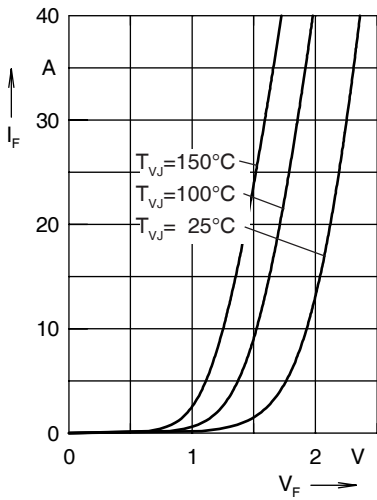

Fig. 1. Forward current  $I_F$  versus  $V_F$

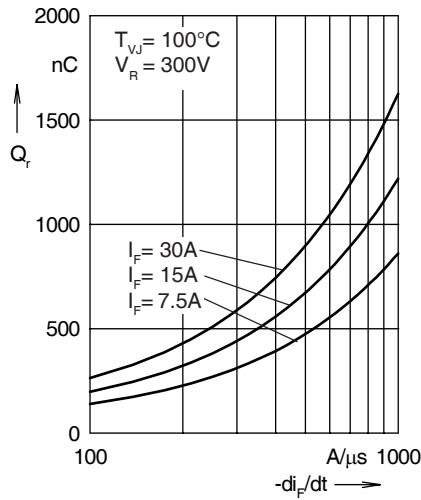

Fig. 2. Reverse recovery charge  $Q_r$  versus  $-di_F/dt$

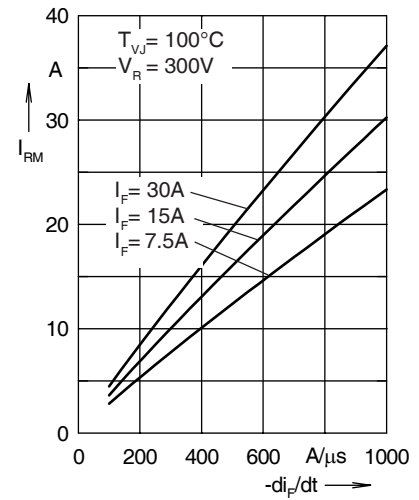

Fig. 3. Peak reverse current  $I_{RM}$  versus  $-di_F/dt$

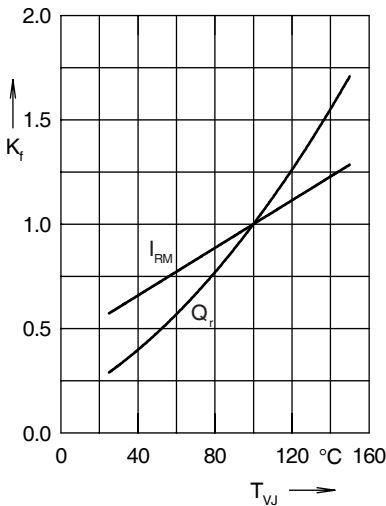

Fig. 4. Dynamic parameters  $Q_r$ ,  $I_{RM}$  versus  $T_{VJ}$

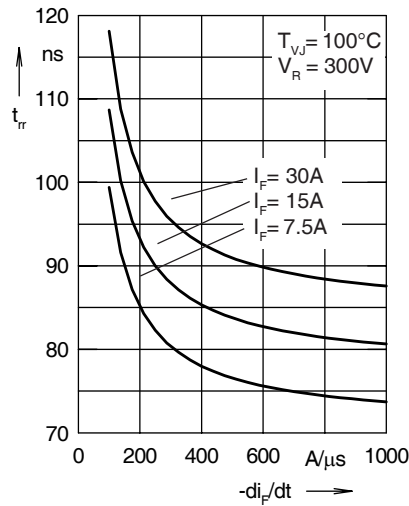

Fig. 5. Recovery time  $t_{tr}$  versus  $-di_F/dt$

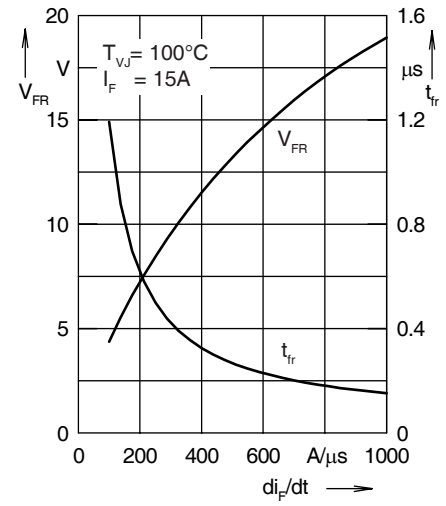

Fig. 6. Peak forward voltage  $V_{FR}$  and  $t_{tr}$  versus  $di_F/dt$

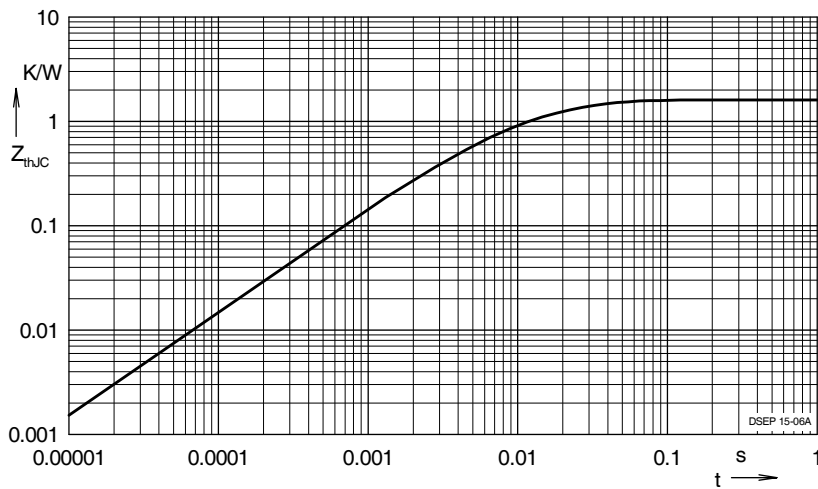

Fig. 7. Transient thermal resistance junction-to-case

Constants for  $Z_{thJC}$  calculation:

i	$R_{thi}$ (K/W)	$t_i$ (s)
1	0.908	0.0052
2	0.35	0.0003
3	0.342	0.017